

MB IDVERSO®

Border Management Solutions



CHALLENGES OF GLOBALIZATION

- Increase of passenger numbers
- Preservation of highest security standards

STATE-OF-THE-ART TECHNOLOGIES

- Automated Border Control (ABC) systems
- Next-generation eMRTDs
- Advance Passenger Information (API)
- Border management systems connected to international watch lists

ADVANTAGES OF ABC SYSTEMS

- More efficient processing of passengers
- Cost reductions
- Increased capacities for border control
- Higher verification standards



INTEGRATED IMMIGRATION MANAGEMENT

- Tailor-made entry / exit solution
- Based on flexible software modules
- Highest security standards

GLOBAL INTEROPERABILITY

- Enhancement of worldwide security
- Processing of all kinds & generations of travel documents



Border Management External System

ELECTRONIC MACHINE-READABLE TRAVEL DOCUMENTS (eMRTDS)

Electronic ID documents accepted for traveling purposes complying with ICAO Doc. 9303

eVISA

Efficient solution for online visa application & verification process

VISA INFORMATION SYSTEMS (VIS)

Facilitation of visa application & of process of identification & verification

ADVANCE PASSENGER INFORMATION (API) SYSTEMS

Submission of information on travelers to country of destination

WATCH LISTS & DATABASES

Information systems with comprehensive databases containing relevant information



Immigration Process

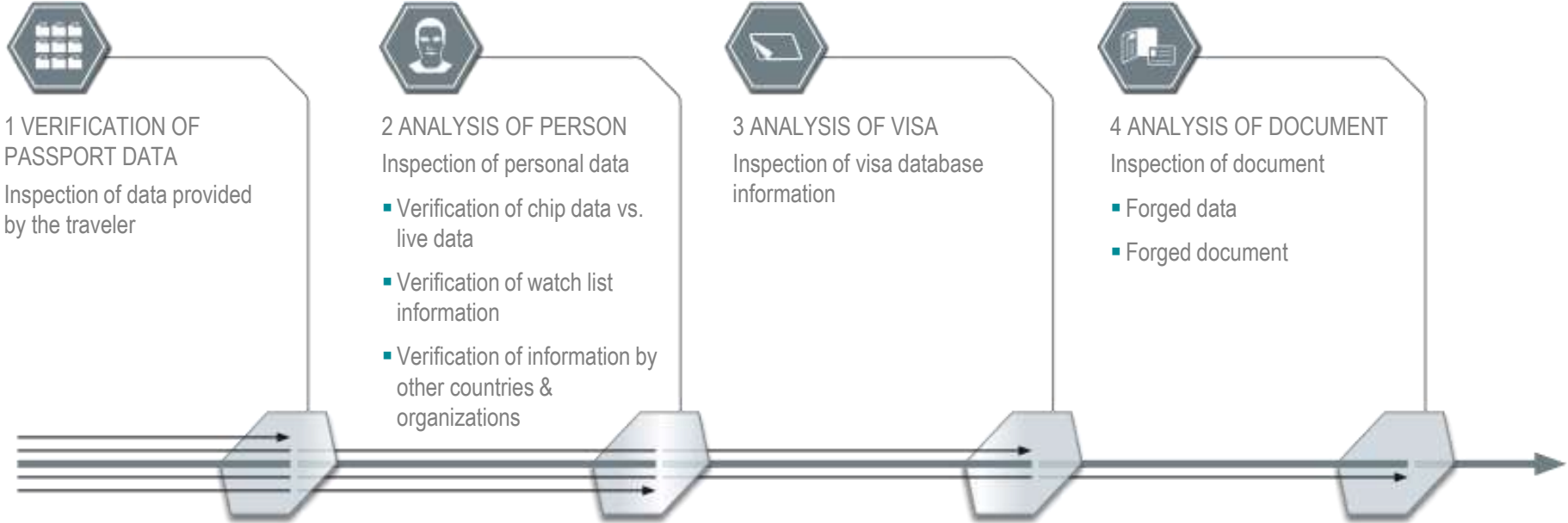

Person & Document Identification & Verification

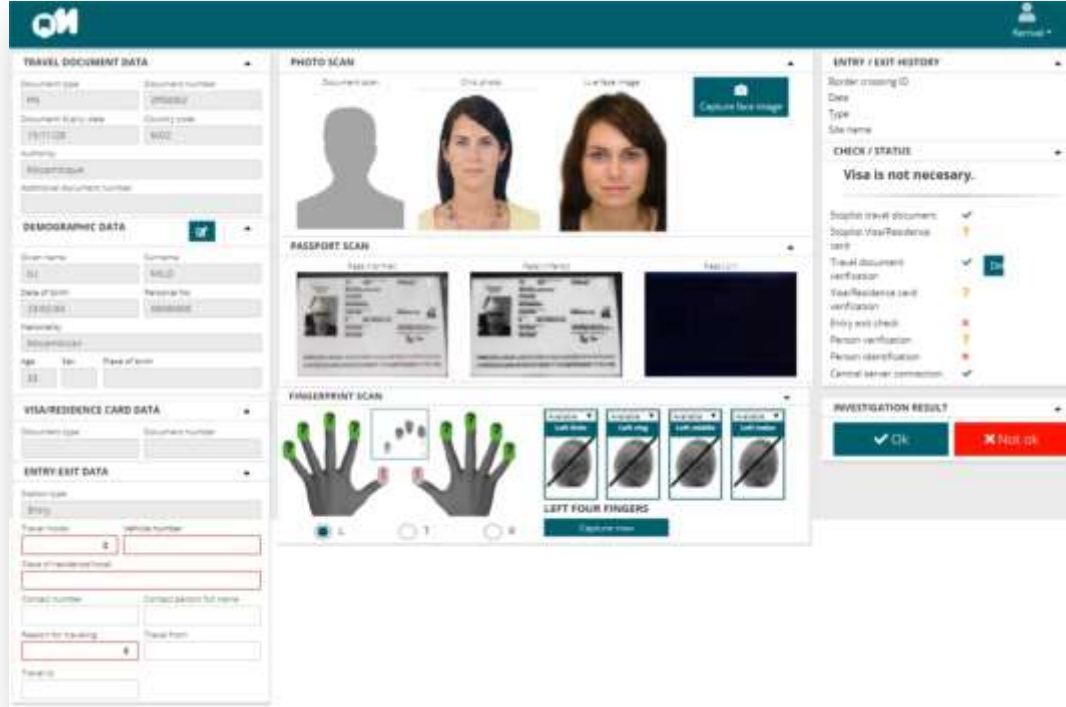

The screenshot shows a software interface for person and document identification. It is divided into several sections:

- TRAVEL DOCUMENT DATA:** Fields for document type, document number, ID, document status, expiry date, authority, and approval document number.
- PHOTO SCAN:** A section for capturing a new image, showing a silhouette and two photo captures of a woman.
- PASSPORT SCAN:** A section for scanning passports, showing two scanned passport pages.
- FINGERPRINT SCAN:** A section for scanning fingerprints, showing a hand with four fingers highlighted and four individual fingerprint scans.
- ENTRY / EXIT HISTORY:** Fields for border crossing ID, date, type, and site name. It includes a 'CHECK / STATUS' section with a dropdown menu and a message 'Visa is not necessary.' Below this is a checklist of verification items: 'Supplies travel documents', 'Supplies Visa/Residence card', 'Travel document verification', 'Visa/Residence card verification', 'Entry exit check', 'Person verification', 'Person identification', and 'Central server connection'.
- INVESTIGATION RESULT:** A section with two buttons: a green 'OK' button and a red 'Not ok' button.
- DEMOGRAPHIC DATA:** Fields for given name, surname, sex, date of birth, nationality, date of acquisition, age, sex, and place of birth.
- VISA/RESIDENCE CARD DATA:** Fields for document type and document number.
- ENTRY-EXIT DATA:** Fields for person type, entry, travel mode, vehicle number, date of residence permit, contact number, contact person full name, reason for tracking, travel from, and passport.



OVERVIEW

- Turn-key Solution Provider
- Various Configurations
- Successful Operational ABC Gates
- Standards Compliant (Frontex & IATA)
- Customizable According to Requirements

Implemented in **8 countries** with over **8.5 million passengers** documents processed.



The Future of Automated Border Control

- Support of all eMRTD, ePassports, eID cards & Mobile-IDs
- Modular structure allowing for individual configurations
- Flexible integration into any environment
- High-speed multi-biometric identity verification
- Strongest international security standards
- Comprehensive verification process of individuals and documents





TCG -00:00:02:20

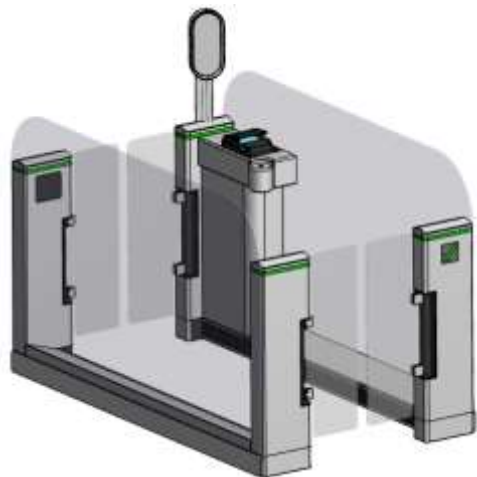

Single Step Gate

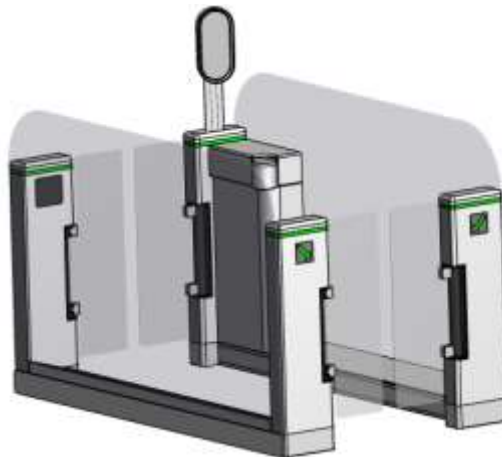

Seamless Gate

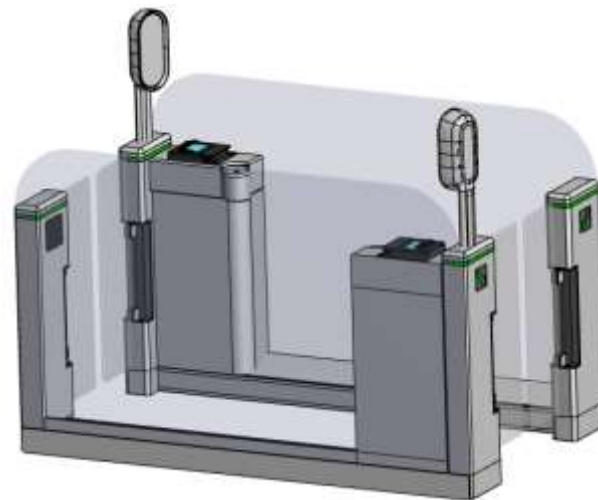

Bi-Directional Gate





IRIS

- Reliable verification feature
- Matching of picture with enrolled data

FACE

- Identification by use of facial biometrics
- Live-ness detection

FINGERPRINT

- Verification by unique pattern of fingerprint
- Single or 4-4-2 finger





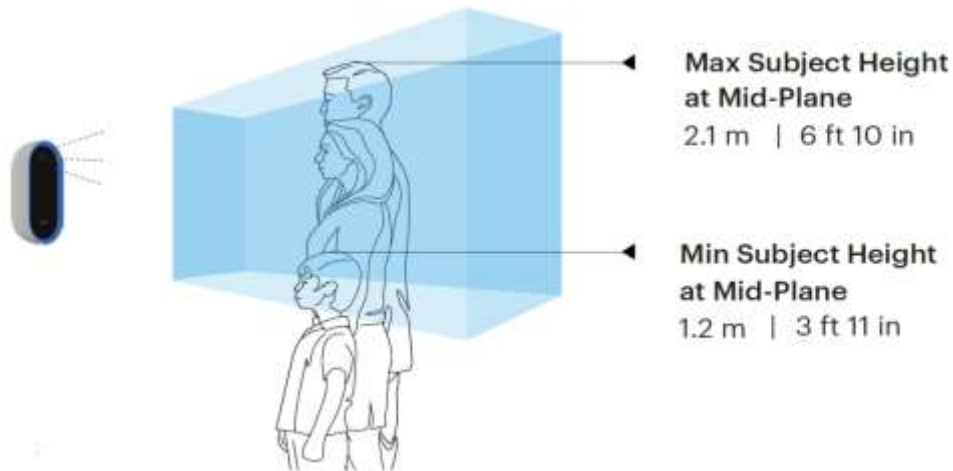

DOCUMENT READER

- ICAO standard compliant
- Passports, ID Cards, Mobile-ID



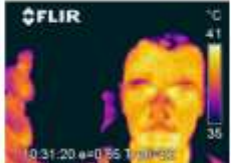

Wide Angle Iris Detection

Without Manipulation		
Setup	IR image	Face camera result
		
manipulative Treatment		
Setup	IR image	Face camera result
		

Live-ness Detection



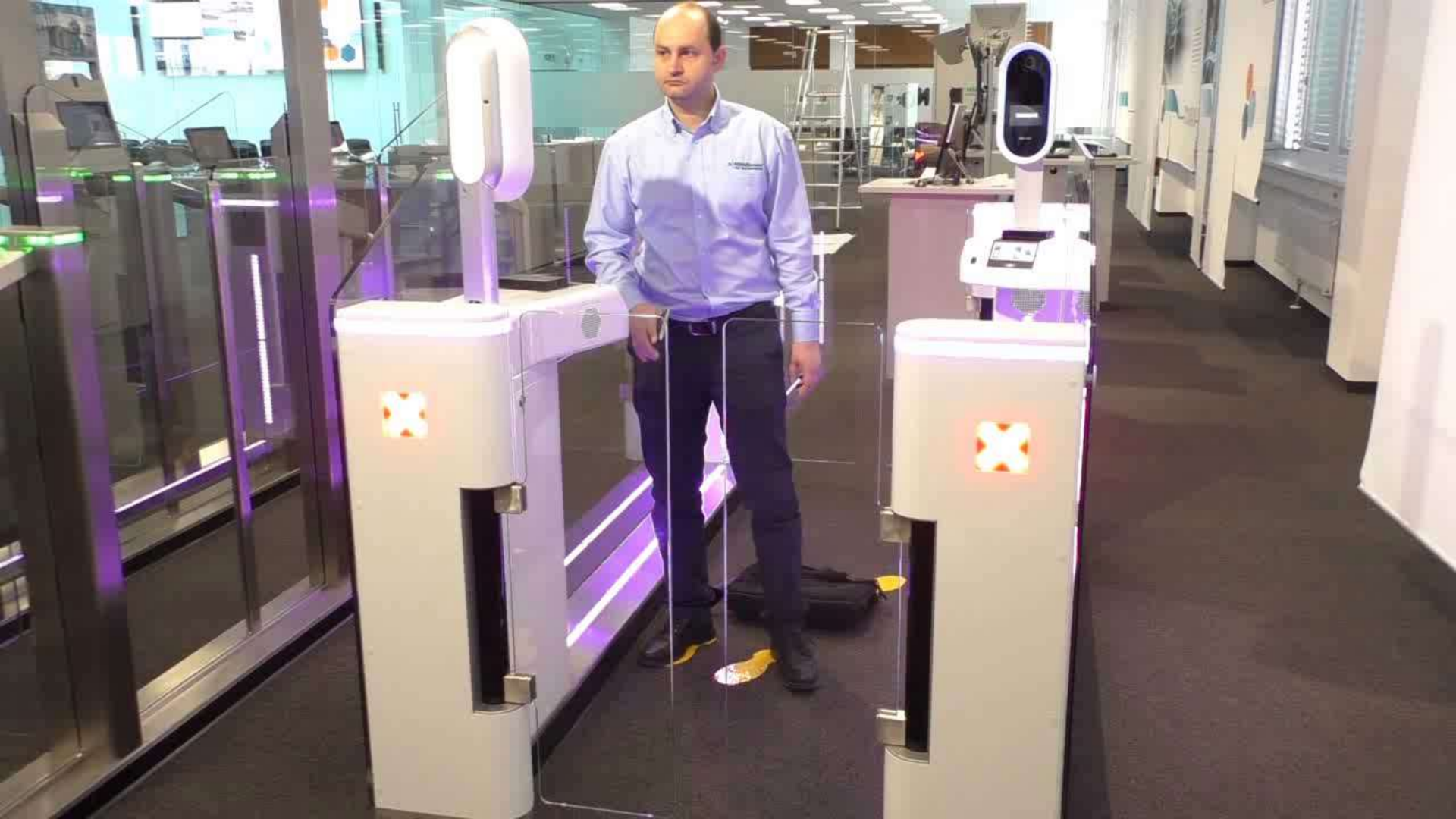

COMING SOON....

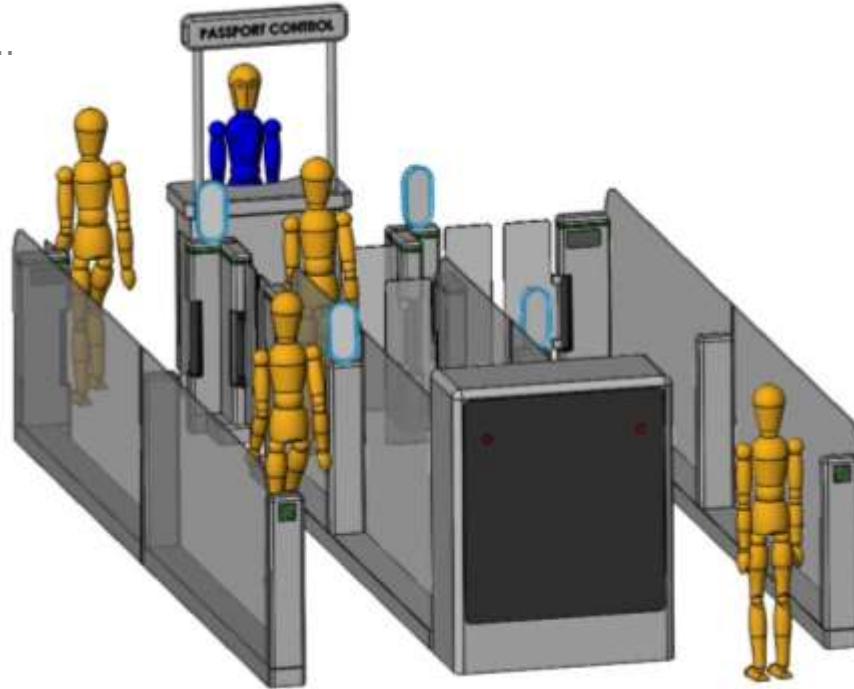



Governmental Application Field

- Verification by police or officials
 - mobile
 - stationary
 - mixture
- also applicable at borders or other security-relevant places
 - airports
 - harbors
 - check points

Application in Private Sector

- Verification by private instances (mobile)
 - car rental, bank/finance, HealthCare,
 - for Telecom ... and many more



MB Steel Reader Mobile

DOCUMENT and PERSON VERIFICATION SOFTWARE

Features

- Inspection of travel documents
- Quality checks after personalization
- Testing of security mechanisms
- Access to contactless chip of eDL, eMRTD...
- Mobile and easy to use
- Intuitive mobile app user interface
- Easy and secure identification of document holder
 - built-in face matching to compare digital image on chip and live photo
 - Document verification against external databases
 - Intuitive visualization of verification results



THANK YOU FOR YOUR ATTENTION!

MÜHLBAUER ID SERVICES GMBH
Josef-Mühlbauer-Platz 1
93426 Roding
Germany

Phone: +49 9461 952 0
Fax: +49 9461 952 1101
Mail: info@muehlbauer.de
Web: www.muehlbauer.de

